

EPS ref.	Ref . Nummer		Dikte	Lengte	Hoogte
C 1002	29747		32,00	139,5	121,0

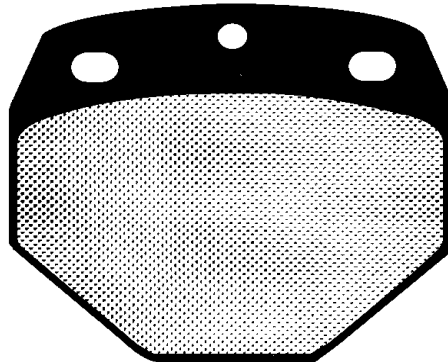

EPS ref.	Ref . Nummer		Dikte	Lengte	Hoogte
I-0000	9910000		14	315,5	110



EPS ref.	Ref . Nummer		Dikte	Lengte	Hoogte
I-0001-L	9910001L		14,5	190	110



EPS ref.	Ref . Nummer		Dikte	Lengte	Hoogte
I-0001-R	9910001R		14,5	190	110



EPS ref.	Ref . Nummer		Dikte	Lengte	Hoogte
I-0002	9912989		13,5	63 / 50	33



EPS ref.	Ref . Nummer		Dikte	Lengte	Hoogte
I-0003	9913249/29015		19,7	257	112

Dikte rugplaat = 6 mm

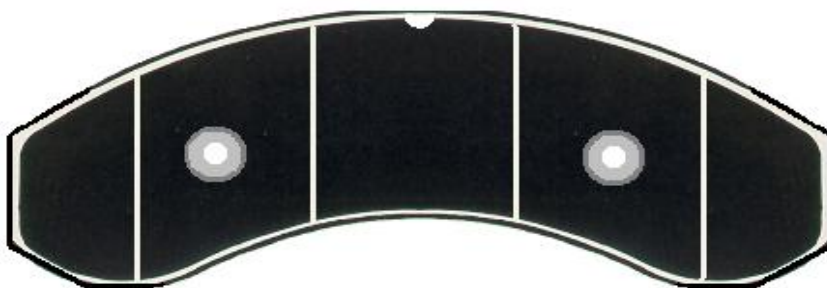

EPS ref.	Ref . Nummer		Dikte	Lengte	Hoogte
I-0004	9913249/29008		17,7	257	112

Dikte rugplaat = 4 mm

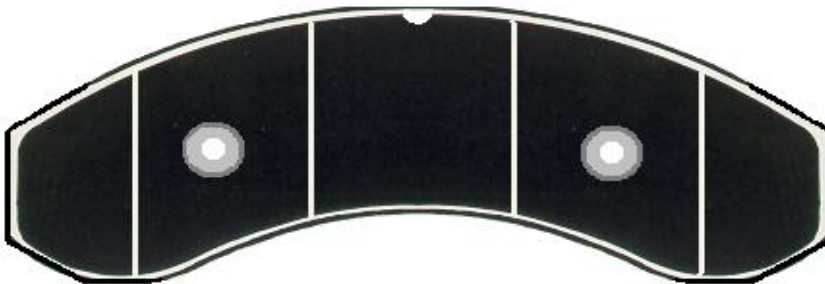

EPS ref.	Ref . Nummer		Dikte	Lengte	Hoogte
I-0005	930404			117	92

Diameter cirkels - 32 mm / sinter material

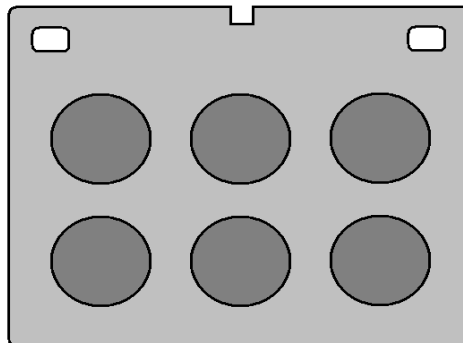

EPS ref.	Ref . Nummer		Dikte	Lengte	Hoogte
I-0006			19	117,5	82,8

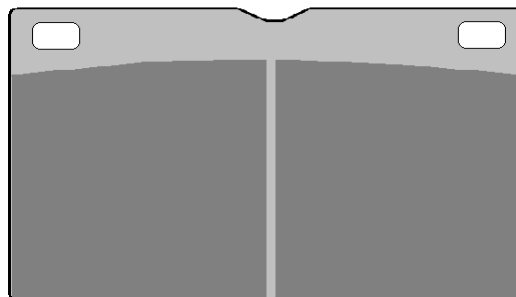

EPS ref.	Ref . Nummer		Dikte	Lengte	Hoogte
I-0007			22	319,2	97,8

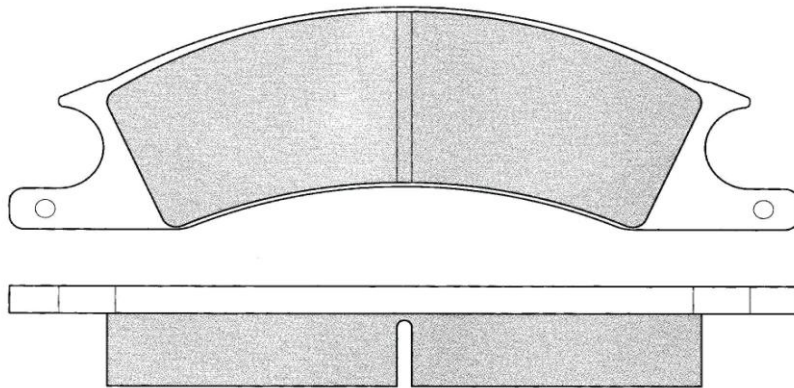

EPS ref.	Ref . Nummer		Dikte	Lengte	Hoogte
I-0008			29	360	123

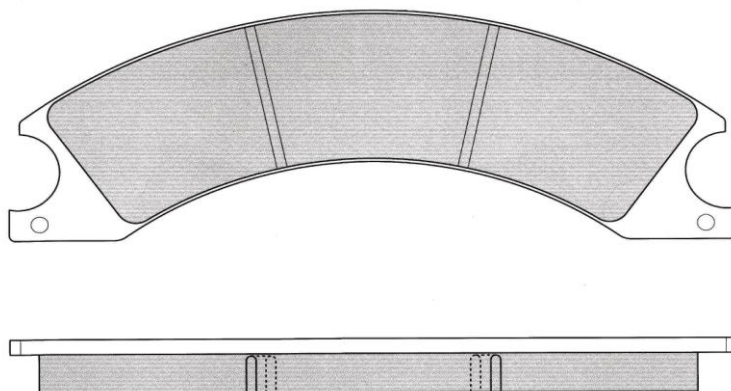

EPS ref.	Ref . Nummer		Dikte	Lengte	Hoogte
I-0009	27834 - C801		35	172	140

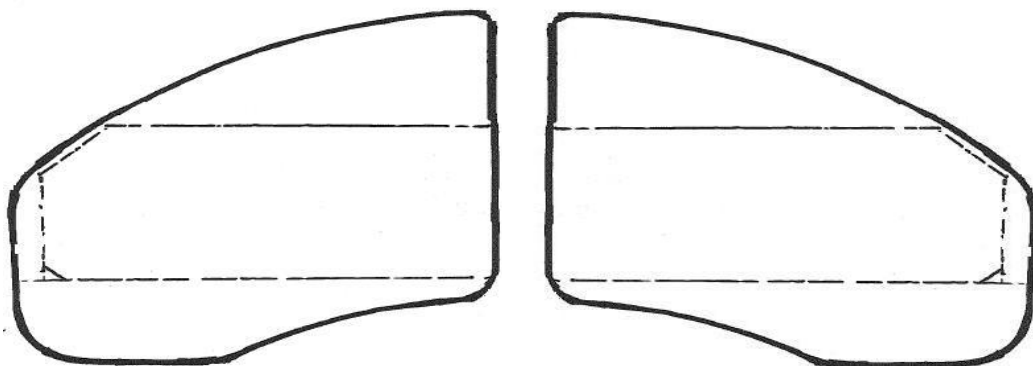

Afmetingen per blok - 2 remblokken per set - Metalen rib op achterzijde remblok

EPS ref.	Ref . Nummer		Dikte	Lengte	Hoogte
I-0010	9912189		22	106	77

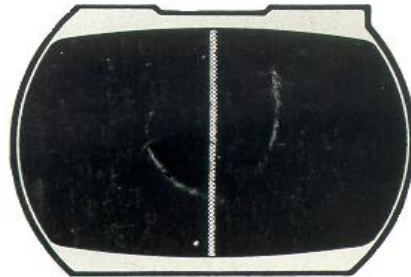

EPS ref.	Ref . Nummer		Dikte	Diam.	Hoogte
I-0019			9	81	-

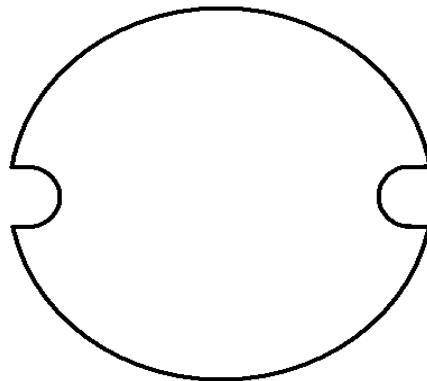

Kwaliteit 560

EPS ref.	Ref . Nummer		Dikte	Diam.	Hoogte
I-0020			9	81	-

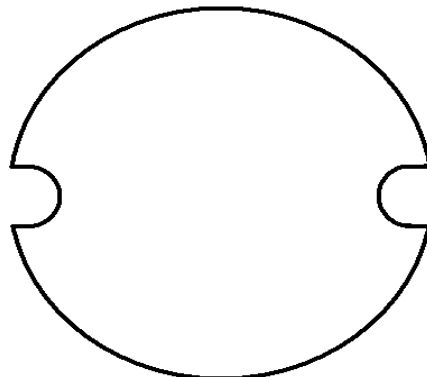

Kwaliteit 233

EPS ref.	Ref . Nummer		Dikte	Lengte	Hoogte
I-0064			14	91	67

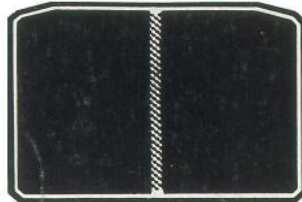

EPS ref.	Ref . Nummer		Dikte	Lengte	Hoogte
I-0065			14	91	67



EPS ref.	Ref . Nummer		Dikte	Lengte	Hoogte
I-0066			14	91	67



EPS ref.	Ref . Nummer		Dikte	Lengte	Hoogte
I-0067			14	91	67

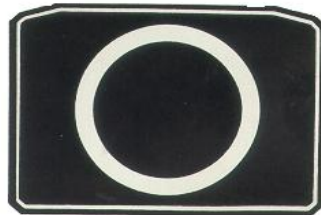

EPS ref.	Ref . Nummer		Dikte	Lengte	Hoogte
I-0068	9912209		22	177	74



EPS ref.	Ref . Nummer		Dikte	Lengte	Hoogte
I-0069-L	9912269		28	398,3	126,9



EPS ref.	Ref . Nummer		Dikte	Lengte	Hoogte
I-0069-R	9912229		28	398,3	126,9



EPS ref.	Ref . Nummer		Dikte	Lengte	Hoogte
I-0070	9912229		22	278	86



EPS ref.	Ref . Nummer		Dikte	Lengte	Hoogte
I-0071	9912249		24	136	104

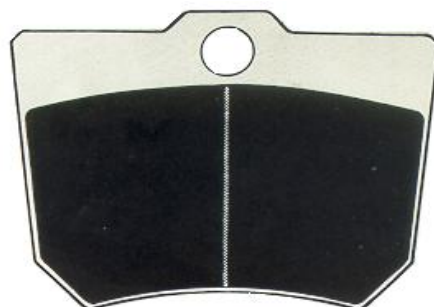



EPS ref.	Ref . Nummer		Dikte	Lengte	Hoogte
I-0072			32	263	87



EPS ref.	Ref . Nummer		Dikte	Lengte	Hoogte
I-0073			26	150,5	114,4

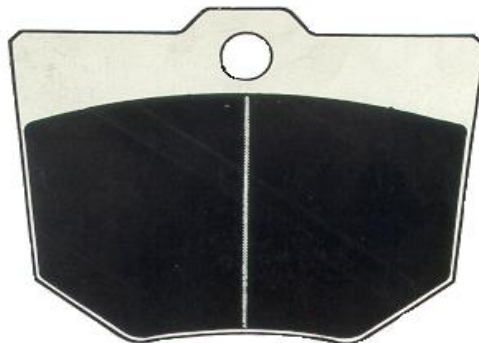

EPS ref.	Ref . Nummer		Dikte	Lengte	Hoogte
I-0074-L			28	326	102

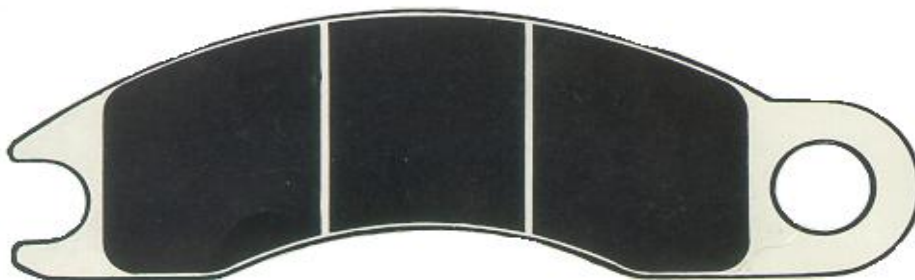

EPS ref.	Ref . Nummer		Dikte	Lengte	Hoogte
I-0074-R			28	326	102



EPS ref.	Ref . Nummer		Dikte	Lengte	Hoogte
I-0075			33	246	107

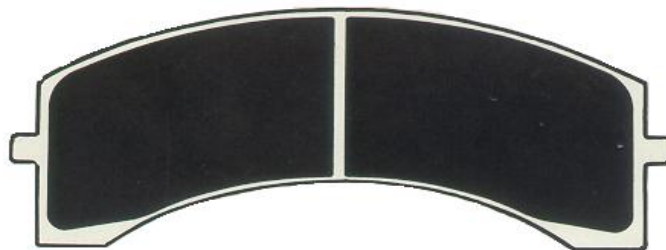

EPS ref.	Ref . Nummer		Dikte	Lengte	Hoogte
I-0076	9913309		27	413	133

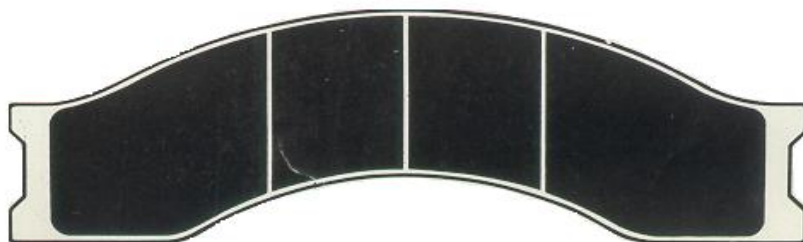

EPS ref.	Ref . Nummer		Dikte	Lengte	Hoogte
I-0078			35,5	455,5	160



EPS ref.	Ref . Nummer		Dikte	Lengte	Hoogte
I-0079			17	173	103



EPS ref.	Ref . Nummer		Dikte	Lengte	Hoogte
I-0080			38	321	156

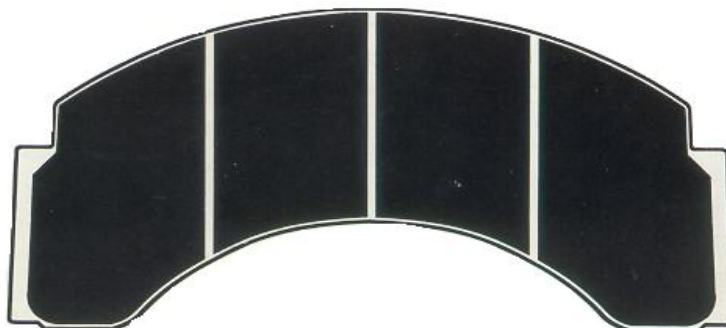

EPS ref.	Ref . Nummer		Dikte	Lengte	Hoogte
I-0081			22,2	180	91

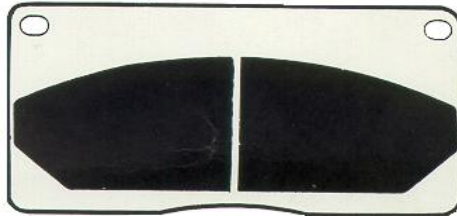

EPS ref.	Ref . Nummer		Dikte	Lengte	Hoogte
I-0086-L			25	320	109



EPS ref.	Ref . Nummer		Dikte	Lengte	Hoogte
I-0086-R			25	320	109



EPS ref.	Ref . Nummer		Dikte	Lengte	Hoogte
I-0344			24	277	103



EPS ref.	Ref . Nummer		Dikte	Lengte	Hoogte
I-1012			15	90	74

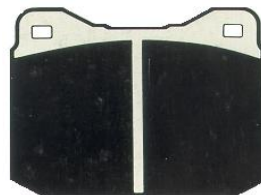

EPS ref.	Ref . Nummer		Dikte	Lengte	Hoogte
FDB143	JBC		15	89,7	73,8

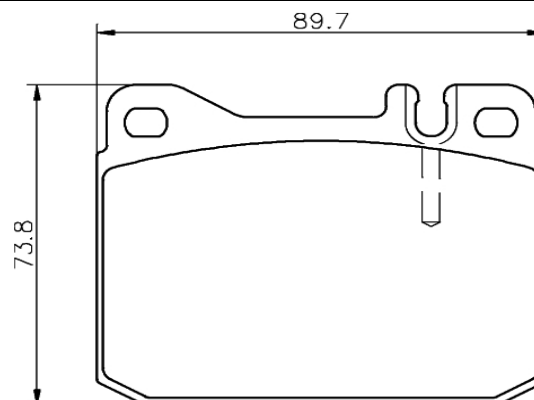

Voor meer remblokken of informatie, kunt u contact opnemen met onze afdeling verkoop op:

For more information, you can contact our sales team at:

**+31 (0)416-337334 / info@epsautomotive.nl**